

## POWER

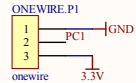

## ONEWIRE

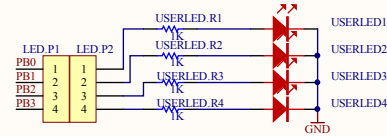

## USER LED

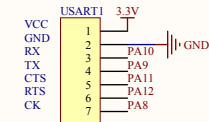

## USART1

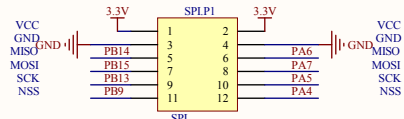

## SPI2

## SPI1

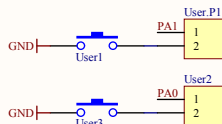

## KEY

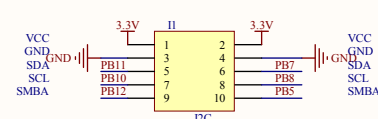

## I2C2

## I2C1

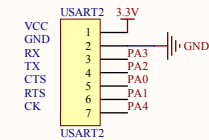

## USART2

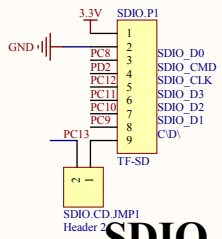

## SDIO

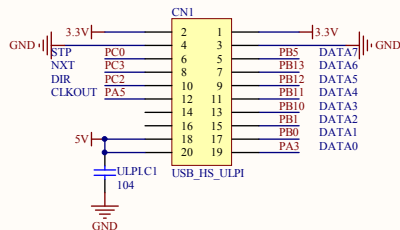

## USB\_HS\_ULPI



## CAN1

## CAN2

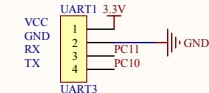

## UART3

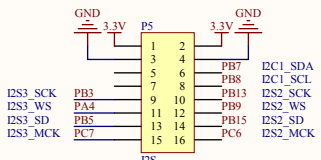

## I2S

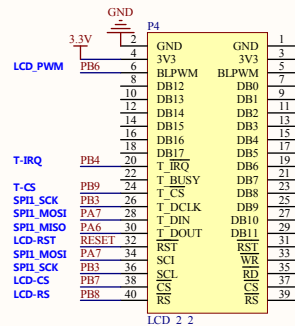

## LCD PORT

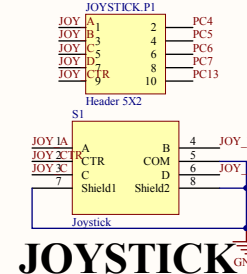

## JOYSTICK

W aveshare ST

+ +

+ +

Title		
Size	Number	Revision
A3		
Date:	2014/1/9	Sheet of
File:	E:\PCB- \Interface SchDas	Drawn By:

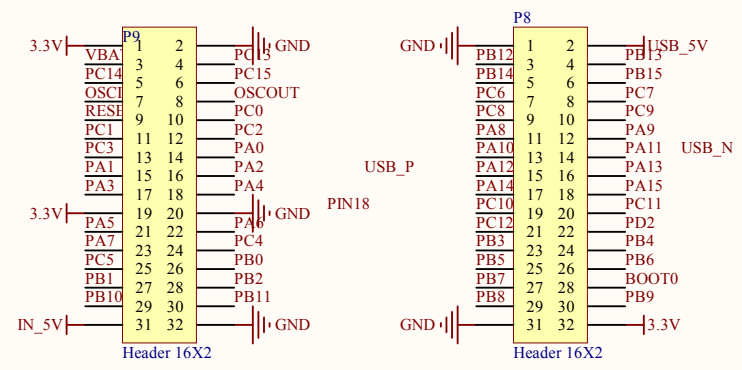
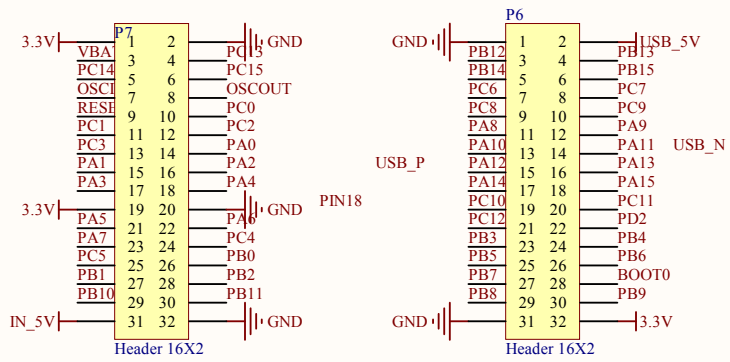

# IO PORT

Title			Open205R		
Size	Number			Revision	
A4					
Date:	2014/1/9	Sheet		of	
File:	E:\PCB-\ MCU\SchDoc	Drawn By:			