

485 Chip Selection

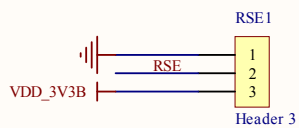

485 Receiving Circuit

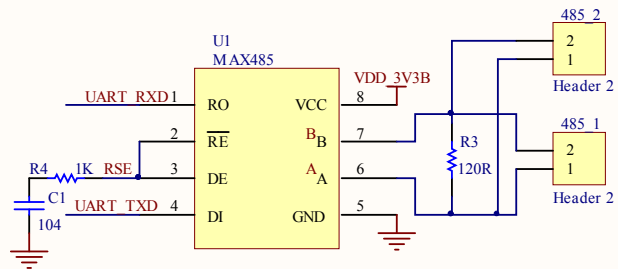

BB black Extension Interface P9

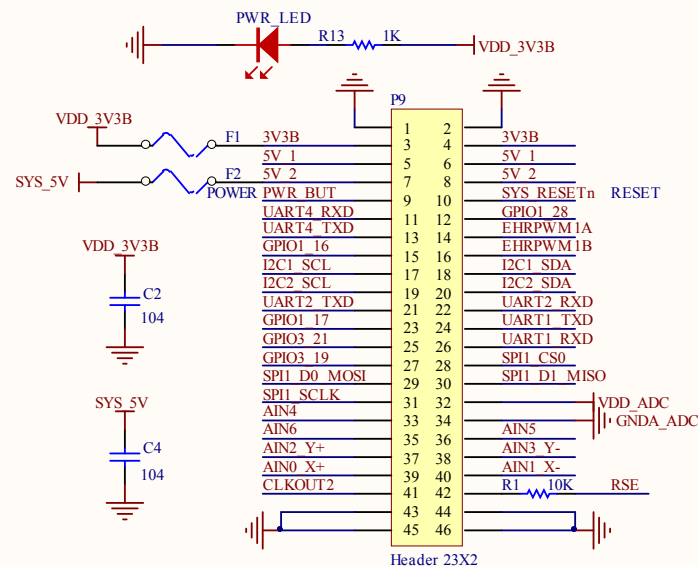

UART RXD JMP

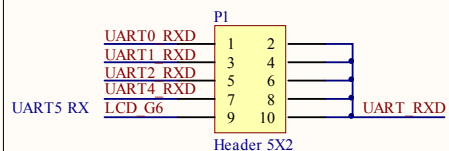

UART TXD JMP

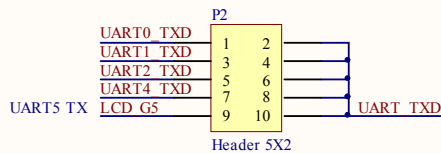

Extension Power

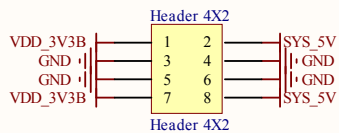

CAN Receiving Circuit

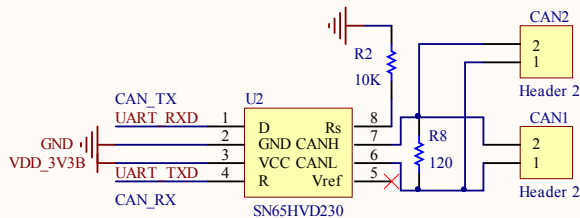

BB black Extension Interface P8

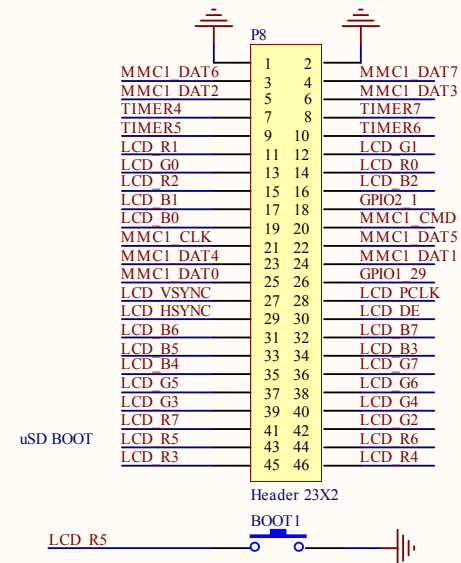

BB black Debug Interface

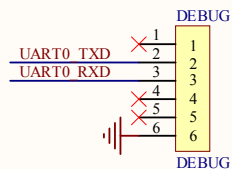

Title 485 CAN CAPE

Size	Number	Revision
A2	1	V1.0
Date:	2014/12/4	Sheet of 1
File:	F:\share\...485_CAN CAPE.SchDoc	Drawn By: waveshare