

Specifications

Insulation Resistance: 1,000M min. at 500V DC
 Dielectric Withstanding Voltage: 700V AC for 1 minute
 Contact Resistance: 30m max. at 10mA/20mV max.
 Current Rating: 1A max.
 Operating Temperature Range: -40°C to +170°C
 Mating Cycles: 10,000 insertions min.

Materials and Finish

Housing: Upper body – Polyphenylenesulfide (PPS)
 Lower body – Polyetherimide (PEI), glass-filled
 Contacts: Beryllium Copper (BeCu)
 Plating: Gold over Nickel

Features

- Two-point contacts and a larger contact width ensures high reliability
- Auto-ejecting type for automated operation (IC is inserted in "one touch" operation and pushing the cover raises it for easy IC removal)
- Available for two types of IC orientation (Live-bug & Dead-bug)



Part Number (Details)

IC120 - 068 4 - 0 04 MF

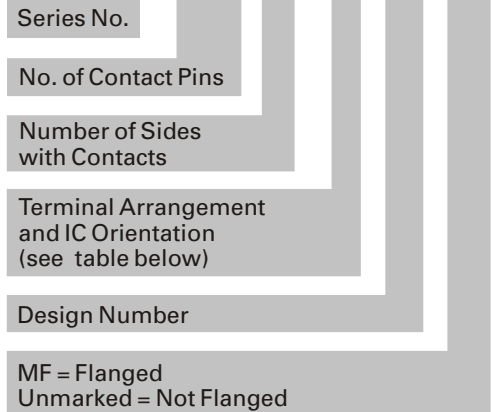

Note:
 Mounting Flange is not available for 18 pins, 22 pins and IC120-0684-304

Outline Socket Dimensions

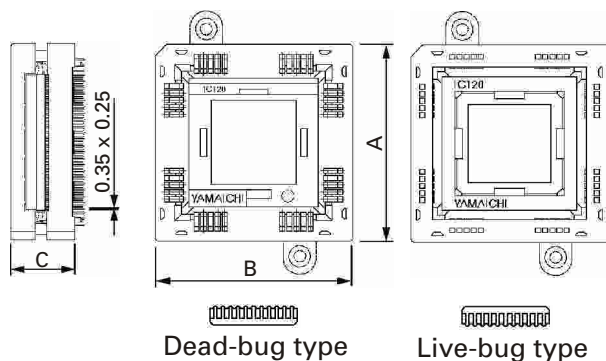

Inserting Direction of IC
 DB = Dead-bug LB = Live-bug

Part Number	Pin Count	IC Insert.	Socket Dim.		
			A	B	C
IC120-0324-009	32	DB	22.5	25.0	18.0
IC120-0324-109	32	LB	22.5	25.0	19.3
*IC120-0324-209	32	DB	22.5	25.0	18.0
*IC120-0324-309	32	LB	22.5	25.0	19.3
IC120-0324-409	32	DB	22.5	25.0	18.0
IC120-0324-509	32	LB	22.5	25.0	19.3
IC120-0444-006	44	DB	28.0	28.0	18.0
IC120-0444-106	44	LB	28.0	28.0	19.3
*IC120-0444-206	44	DB	28.0	28.0	18.0
*IC120-0444-306	44	LB	28.0	28.0	19.3
IC120-0444-406	44	DB	28.0	28.0	18.0
IC120-0444-506	44	LB	28.0	28.0	19.3
IC120-0524-007	52	DB	30.0	30.0	18.0
IC120-0524-107	52	LB	30.0	30.0	19.3
*IC120-0524-207	52	DB	30.0	30.0	18.0
*IC120-0524-307	52	LB	30.0	30.0	19.3
IC120-0524-407	52	DB	30.0	30.0	18.0
IC120-0524-507	52	LB	30.0	30.0	19.3
IC120-0684-004	68	DB	35.0	35.0	18.0
IC120-0684-104	68	LB	35.0	35.0	19.3
*IC120-0684-204	68	DB	35.0	35.0	18.0
*IC120-0684-304	68	LB	35.0	35.0	19.3
IC120-0684-404	68	DB	35.0	35.0	18.0
IC120-0684-504	68	LB	35.0	35.0	19.3
IC120-0844-003	84	DB	40.0	40.0	18.0
IC120-0844-103	84	LB	40.0	40.0	19.3
*IC120-0844-203	84	DB	40.0	40.0	18.0
*IC120-0844-303	84	LB	40.0	40.0	19.3
IC120-0844-403	84	DB	40.0	40.0	18.0
IC120-0844-503	84	LB	40.0	40.0	19.3

* Most compatible socket type

Part Number	Pin Count	IC Insert.	Socket Dim.		
			A	B	C
*IC120-0184-002	18	DB	17.0	21.5	18.0
*IC120-0184-102	18	LB	17.0	21.5	19.3
IC120-0184-202	18	DB	17.0	21.5	18.0
IC120-0184-302	18	LB	17.0	21.5	19.3
IC120-0204-005	20	DB	20.0	20.0	18.0
*IC120-0204-205	20	DB	20.0	20.0	18.0
IC120-0204-405	20	DB	20.0	20.0	18.0
*IC120-0224-001	22	DB	17.0	21.5	18.0
*IC120-0224-101	22	LB	17.0	21.5	19.3
IC120-0224-201	22	DB	17.0	21.5	18.0
IC120-0224-301	22	LB	17.0	21.5	19.3
IC120-0284-008	28	DB	23.0	23.0	18.0
IC120-0284-108	28	LB	23.0	23.0	19.3
*IC120-0284-208	28	DB	23.0	23.0	18.0
*IC120-0284-308	28	LB	23.0	23.0	19.3
IC120-0284-408	28	DB	23.0	23.0	18.0
*IC120-0284-508	28	LB	23.0	23.0	19.3

Recommended PCB Layouts

Top View from Socket

18 pins

IC120-0184-002
IC120-0184-102

IC120-0184-202
IC120-0184-302

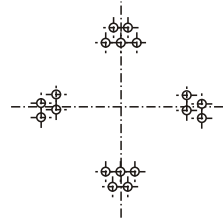
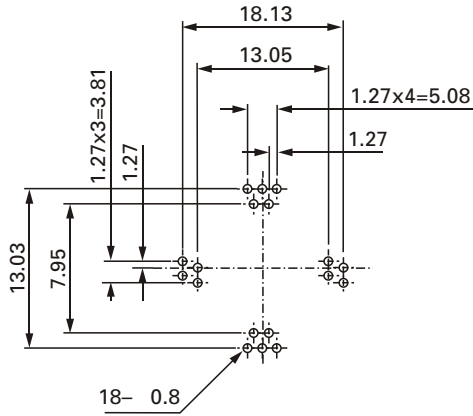

20 pins

IC120-0204-005

IC120-0204-205

IC120-0204-405

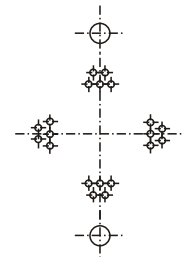
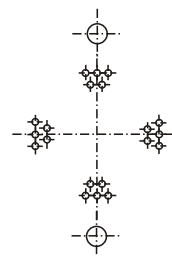
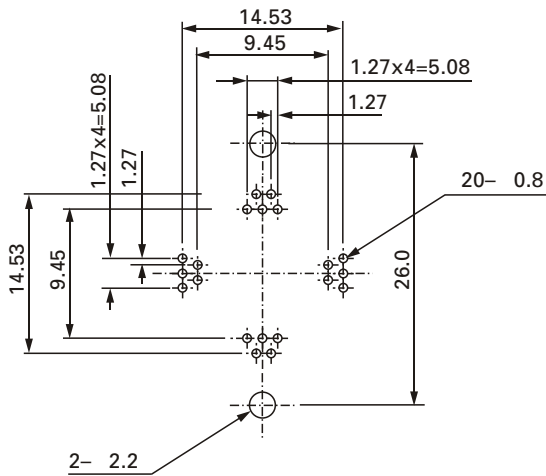

Most compatible
socket type

22 pins

IC120-0224-001
IC120-0224-101

IC120-0224-201
IC120-0224-301

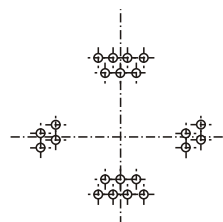
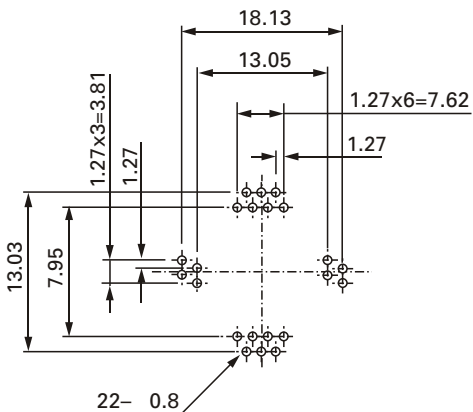

Recommended PCB Layouts

Top View from Socket

28 pins

IC120-0284-008
IC120-0284-108

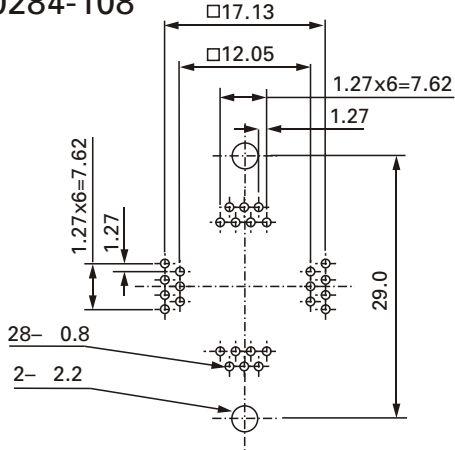

IC120-0284-208
IC120-0284-308

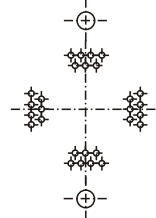

Most compatible socket type

IC120-0284-408
IC120-0284-508

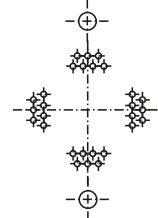

32 pins

IC120-0324-009
IC120-0324-109

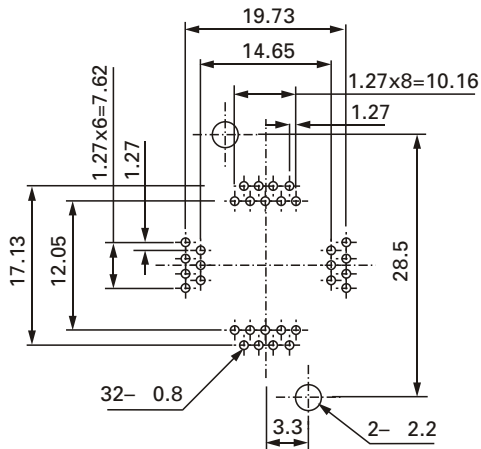

IC120-0324-209
IC120-0324-309

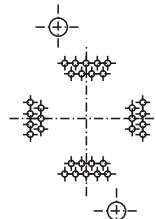

Most compatible socket type

IC120-0324-409
IC120-0324-509

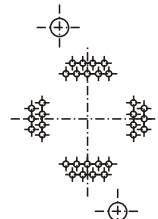

44 pins

IC120-0444-006
IC120-0444-106

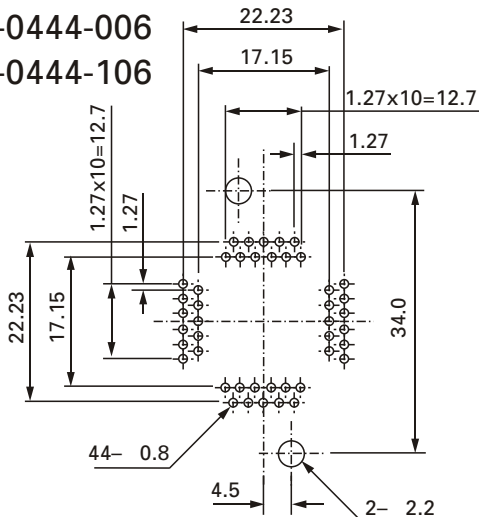

IC120-0444-206
IC120-0444-306

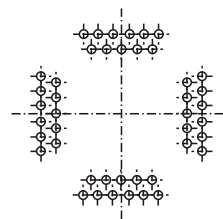

Most compatible socket type

IC120-0444-406
IC120-0444-506

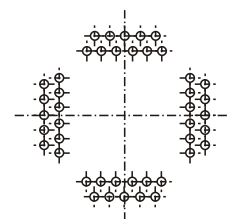

Recommended PCB Layouts

Top View from Socket

52 pins

IC120-0524-007
IC120-0524-107

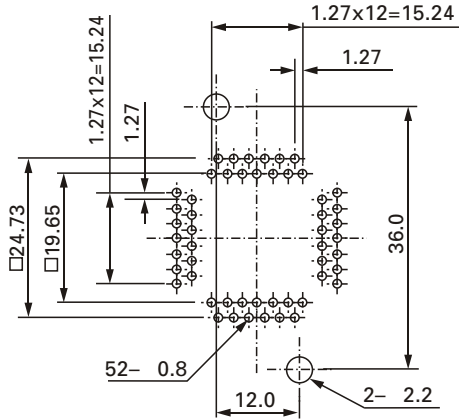

IC120-0524-207
IC120-0524-307

IC120-0524-407
IC120-0524-507

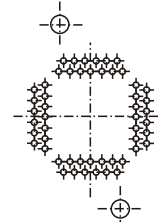
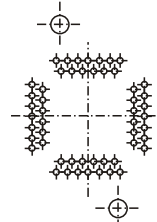

Most compatible socket type

68 pins

IC120-0684-004
IC120-0684-104

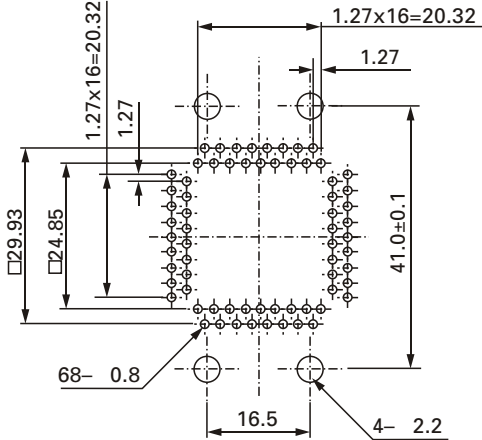

IC120-0684-204
IC120-0684-304

IC120-0684-404
IC120-0684-504

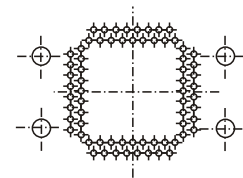
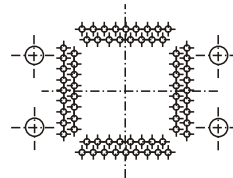

Most compatible socket type

84 pins

IC120-0844-003
IC120-0844-103

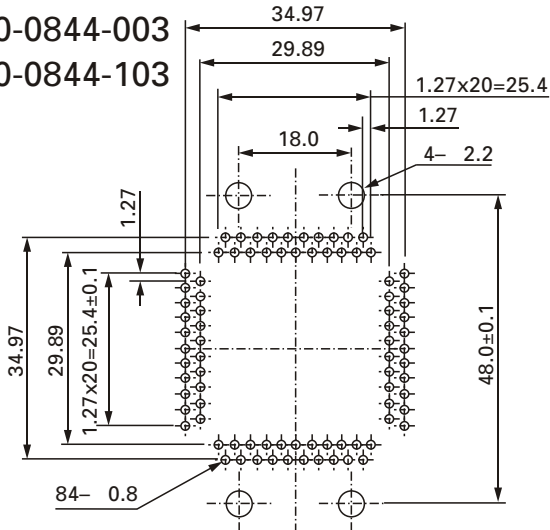

IC120-0844-203
IC120-0844-303

IC120-0844-403
IC120-0844-503

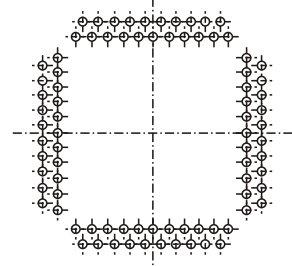
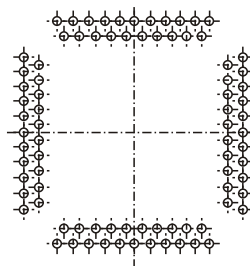

Most compatible socket type